

Ginkgo® International Ltd.

*Designing Quality®
Since 1977*



GINKGO

Retail Price List

Prices Effective

January 1, 2016

Exceptional Stainless Flatware



- Prices are subject to change without notice.
- All orders are placed with Ginkgo’s office in Woodridge, IL.
- Payments may be made by Credit Card or Personal Check.
- We accept VISA, Master Card, Discover and American Express. Each transaction will be charged a 5% processing fee.
- A \$5.00 Service charge will be applied to all orders under \$100.00.
- \$250.00 order required to process credit.

For U.P.C. # Use Preface of: 079914

Table of Contents

Pattern Name	Collection	Page
Bergen, Bonnie™	Ginkgo®	.1
Corrie, Lafayette	Ginkgo®	.2
Le Prix®, Le Prix® Panda Babies,	Ginkgo®	.3
Panda Baby Stainless, Child & Baby		.3
Linden, Mercury	Ginkgo®	.4
President, Sanibel Surf®	Ginkgo®	.5
Simple, Skandia	Ginkgo®	.6
Varberg	Ginkgo®	.7
Burton, Charlie	Ginkgo® Select	.8
Fontur™ Platinum, Naples	Ginkgo® Select	.9
Norse™, Sea Drift®	Ginkgo® Select	.10
Starlight®, Woodruff	Ginkgo® Select	.11
Steak Knife Collection		.12
Alsace®	Helmick®	.13
Celine Platinum™, Firenze™	Helmick®	.14
Fleur de Lis®	Helmick®	.15
Ginkgo Leaf™	Helmick®	.16
LaMer™, Lyon™ New!	Helmick®	.17
Mariko™, Pendulum®	Helmick®	.18
Pineapple™	Helmick®	.19
Roberto, Shimmer	Helmick®	.20
Classic English, Celtic (formerly Crusader)	Helmick Premier®	.21
Flight™, Oak Leaf™	Helmick Premier®	.22
Windsor Shell	Helmick Premier®	.23
Yaxell Knives - Super GOU Series, GOU Series		.24
RAN Series & Tsuchimon Series		.25
Gift & Block Sets, Magnet Bars New! & Sharpening		.26
Kitchen Tool Collection		.27
Displays, Panda Babies		.28
Displays: 3 Tier Open Stock, 9 Pocket Party Pieces		.29

This price list supersedes all other price list.

Ginkgo® Collection

Ginkgo® Collection

(Stainless - All Satin Finish)

Bergen™

Item #	Description	PK	Suggested Retail
36105-7	5 PC Place Setting	4	20.00
36100-2	Dinner Knife	12	6.75
36101-9	Dinner Fork	12	5.25
36102-6	Salad Fork	12	4.75
36103-3	Dinner Spoon	12	5.25
36104-0	Teaspoon	12	4.75
36109-5	Butter Spreader	12	3.00
36111-8	Cocktail Fork	12	3.00
36140-8	Demitasse Spoon	12	3.00
36108-8	Butter Knife	12	6.25
36107-1	Serving Spoon	12	10.00
36113-2	Pierced Serving Spoon	12	10.00
36118-7	Sauce Ladle	12	10.00
36112-5	Cold Meat Fork	12	10.00
36115-6	20 PC Set	6	60.00
36142-2	42 PC Set (8-5Pc Place Setting and 2-Serving Spoons)	4	120.00
36131-6	4 PC Hostess Set Serving Spoon, Prc'd Spoon, Cold Meat Fork, Sauce Ladle	6	35.00

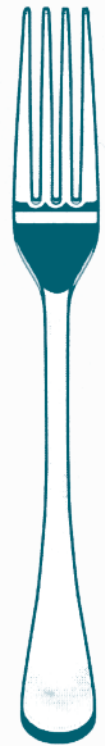

Ginkgo® Collection

(Stainless - Full Mirror Finish)

Bonnie™

Item #	Description	PK	Suggested Retail
35005-1	5 PC Place Setting	4	20.00
35000-1	Dinner Knife	12	6.75
35001-3	Dinner Fork	12	5.25
35002-6	Salad Fork	12	4.75
35003-7	Dinner Spoon	12	5.25
35004-4	Teaspoon	12	4.75
35008-2	Butter Knife	12	6.25
35007-5	Serving Spoon	6	10.00
35013-6	Pierced Serving Spoon	6	10.00
35018-1	Sauce Ladle	6	10.00
35012-4	Cold Meat Fork	6	10.00
35015-0	20 PC Set	4	60.00
35042-6	42 PC Set (8-5Pc Place Setting and 2-Serving Spoons)	4	120.00
35031-0	4 PC Hostess Set Serving Spoon, Prc'd Spoon, Cold Meat Fork, Sauce Ladle	4	35.00





Item #	Description	PK	Suggested Retail
32005-0	5 PC Place Setting	4	20.00
32000-9	Dinner Knife	12	6.75
32001-6	Dinner Fork	12	5.25
32002-3	Salad Fork	12	4.75
32003-0	Dinner Spoon	12	5.25
32004-7	Teaspoon	12	4.75
32008-5	Butter Knife	12	6.25
32007-8	Serving Spoon	6	10.00
32013-9	Pierced Serving Spoon	6	10.00
32018-4	Sauce Ladle	6	10.00
32012-2	Cold Meat Fork	6	10.00
32015-3	20 PC Set	4	60.00
32042-9	42 PC Set (8-5Pc Place Setting and 2-Serving Spoons)	4	120.00
32031-3	4 PC Hostess Set Serving Spoon, Prc'd Spoon, Cold Meat Fork, Sauce Ladle	4	35.00

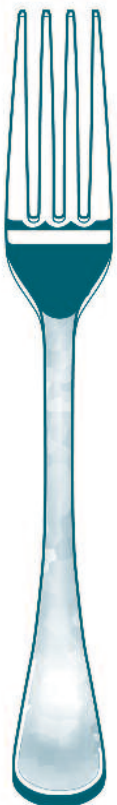

Item #	Description	PK	Suggested Retail
36005-0	5 PC Place Setting	4	20.00
36000-5	Dinner Knife	12	6.75
36001-2	Dinner Fork	12	5.25
36002-9	Salad Fork	12	4.75
36003-6	Dinner Spoon	12	5.25
36004-3	Teaspoon	12	4.75
36009-8	Butter Spreader	12	3.00
36011-1	Cocktail Fork	12	3.00
36040-1	Demitasse Spoon	12	3.00
36020-3	Ice Tea Spoon	12	4.00
36025-8	Grapefruit Spoon	12	4.00
36008-1	Butter Knife	12	6.25
36007-4	Serving Spoon	12	10.00
36013-5	Pierced Serving Spoon	12	10.00
36018-0	Sauce Ladle	12	10.00
36012-8	Cold Meat Fork	12	10.00
36024-1	Bouillon Spoon	12	4.00
36026-5	Steak Knife	12	7.50
36029-6	Steak Knife Set/4-Gift Boxed	4	25.00
36015-9	20 PC Set	6	60.00
36042-5	42 PC Set (8-5Pc Place Setting and 2-Serving Spoons)	4	120.00
36031-9	4 PC Hostess Set Serving Spoon, Prc'd Spoon, Cold Meat Fork, Sauce Ladle	6	35.00

Ginkgo® Collection *(Stainless with ABS plastic handles)*

Le Prix®

HANDLE COLORS: 00-Green, 01-Bright Blue, 03-White, 04-Mimosa Yellow
 05-Navy, 07-Black, 12-Milano Red, 13-Moss Green, **New! Color: 18-Persimmon***

**Available in 5pc place settings and 20pc sets only*

Item #	Description	PK	Suggested Retail
201__	5 PC Place Setting	4	20.00
202__	Dinner Knife	12	4.00
203__	Dinner Fork	12	4.00
204__	Salad Fork	12	4.00
205__	Dinner Spoon	12	4.00
206__	Teaspoon	12	4.00
209__	Demitasse Spoon	12	3.00
210__	Butter Spreader	12	3.00
211__	Cocktail Fork	12	3.00
215__	Serving Spoon	12	7.00
216__	Pierced Serving Spoon	12	7.00
217__	Cold Meat Fork	12	7.00
218__	Gravy/Sauce Ladle	12	7.00
200__	20 PC Set	6	60.00
212__	4 PC Hostess Set Serving Spoon, Prc'd Spoon, Cold Meat Fork, Sauce Ladle	6	25.00
208__	Set of 4 - Butter Spreaders	12	12.00
207__	Set of 4 - Demitasse Spoons	12	12.00
213__	Set of 4 - Cocktail Forks	12	12.00

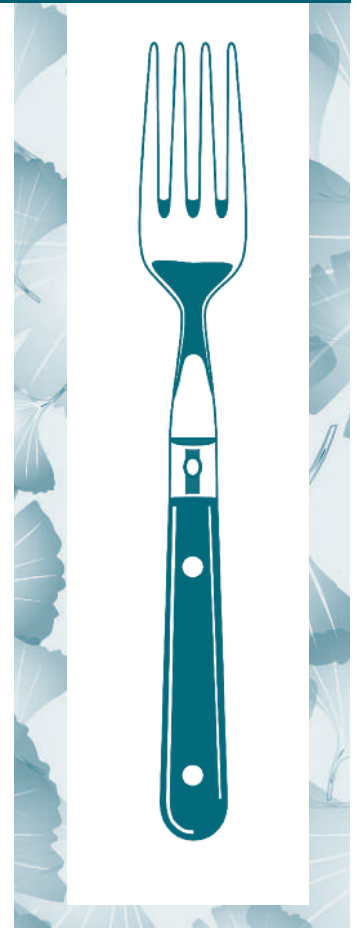

Ginkgo® Collection

PANDA BABIES

Le Prix®

Le Prix® Child Colors -14 Baby Blue -15 Pink -16 Spring Green

Item #	Description	Suggested Retail
209__	Baby Spoon	3.00
210__	Baby Knife	3.00
211__	Baby Fork	3.00
219__	3pc Child & Baby Set (Knife, Fork, Spoon)	10.00
214__	3 Spoon Set	10.00



Panda Baby Stainless Child & Baby

Item #	Description	PK	Suggested Retail
36202-3	3 PC Baby & Toddler-Lafayette	12	12.00
36203-0	3 PC Child - Lafayette	12	15.00
36206-1	6 PC Progress - Lafayette	12	25.00
36700-4	3 PC Child Set - Charlie	12	12.00

Panda Babies Display on page 24

Linden™

(Mirror Finish Stainless)

Ginkgo® Collection



Item #	Description	PK	Suggested Retail
34005-2	5 PC Place Setting	4	20.00
34000-7	Dinner Knife	12	6.75
34001-4	Dinner Fork	12	5.25
34002-1	Salad Fork	12	4.75
34003-8	Dinner Spoon	12	5.25
34004-5	Teaspoon	12	4.75
34009-0	Butter Spreader	12	3.00
34010-6	Linden Luncheon/Dessert Knife	12	6.00
34011-3	Cocktail Fork	12	3.00
34040-3	Demitasse Spoon	12	3.00
34008-3	Butter Knife	12	6.25
34020-5	Iced Tea Spoon	12	4.75
34007-6	Serving Spoon	12	10.00
34013-7	Pierced Serving Spoon	12	10.00
34012-0	Cold Meat Fork	12	10.00
34018-2	Sauce Ladle	12	10.00
34015-1	20 PC Set	6	60.00
34042-7	42 PC Set (8-5Pc Place Setting and 2-Serving Spoons)	4	120.00
34031-1	4 PC Hostess Set Serving Spoon, Prc'd Spoon, Cold Meat Fork, Sauce Ladle	6	35.00

Mercury

(Stainless Steel)

Ginkgo® Collection



Item #	Description	PK	Suggested Retail
54005-6	5 PC Place Setting	4	20.00
54000-1	Dinner Knife	12	6.75
54001-8	Dinner Fork	12	5.25
54002-5	Salad Fork	12	4.75
54003-2	Dinner Spoon	12	5.25
54004-9	Teaspoon	12	4.75
54007-0	Serving Spoon	6	10.00
54013-1	Pierced Serving Spoon	6	10.00
54018-6	Sauce Ladle	6	10.00
54012-4	Cold Meat Fork	6	10.00
54015-5	20 PC Set	4	60.00
54042-5	42 PC Set (8-5Pc Place Setting and 2-Serving Spoons)	4	120.00
54031-5	4 PC Hostess Set Serving Spoon, Prc'd Spoon, Cold Meat Fork, Sauce Ladle	4	35.00

Ginkgo® Collection — (Stainless Steel Mirror Finish)

President

Item #	Description	PK	Suggested Retail
49005-4	5 PC Place Setting	4	20.00
49000-9	Dinner Knife	12	6.75
49001-6	Dinner Fork	12	5.25
49002-3	Salad Fork	12	4.75
49003-0	Dinner Spoon	12	5.25
49004-7	Teaspoon	12	4.75
49008-5	Butter Knife	12	6.25
49007-8	Serving Spoon	12	10.00
49012-2	Cold Meat Fork	12	10.00
49013-9	Pierced Serving Spoon	12	10.00
49018-4	Sauce Ladle	12	10.00
49015-3	20 PC Set	4	60.00
49042-9	42 PC Set (8-5Pc Place Setting and 2-Serving Spoons)	4	120.00
49031-3	4 PC Hostess Set Serving Spoon, Prc'd Spoon, Cold Meat Fork, Sauce Ladle	4	35.00



Ginkgo® Collection — (Stainless Steel Mirror Finish)

Sanibel Surf®

Item #	Description	PK	Suggested Retail
38005-8	5 PC Place Setting	4	20.00
38000-3	Dinner Knife	12	6.75
38001-0	Dinner Fork	12	5.25
38002-7	Salad Fork	12	4.75
38003-4	Dinner Spoon	12	5.25
38004-1	Teaspoon	12	4.75
38009-6	Butter Spreader	12	3.00
38011-9	Cocktail Fork	12	3.00
38040-9	Demitasse Spoon	12	3.00
38008-9	Butter Knife	12	6.25
38007-2	Serving Spoon	12	10.00
38013-3	Pierced Serving Spoon	12	10.00
38018-8	Sauce Ladle	12	10.00
38012-6	Cold Meat Fork	12	10.00
38015-7	20 PC Set	6	60.00
38042-3	42 PC Set (8-5Pc Place Setting and 2-Serving Spoons)	4	120.00
38031-7	4 PC Hostess Set Serving Spoon, Prc'd Spoon, Cold Meat Fork, Sauce Ladle	6	35.00



Simple®*(Mirror Finish)***Ginkgo® Collection**

Item #	Description	PK	Suggested Retail
18505-9	5 PC Place Setting	4	20.00
18500-4	Dinner Knife	12	6.75
18501-1	Dinner Fork	12	5.25
18502-8	Salad Fork	12	4.75
18503-5	Dinner Spoon	12	5.25
18504-2	Teaspoon	12	4.75
18508-0	Butter Knife	12	6.25
18507-3	Serving Spoon	12	10.00
18513-4	Pierced Serving Spoon	12	10.00
18518-9	Sauce Ladle	12	10.00
18512-7	Cold Meat Fork	12	10.00
18520-2	20 PC Set	6	60.00
18542-4	42 PC Set (8-5Pc Place Setting and 2-Serving Spoons)	4	120.00
18531-8	4 PC Hostess Set Serving Spoon, Prc'd Spoon, Cold Meat Fork, Sauce Ladle	6	35.00

Skandia™*(18/0 Stainless Mirror Finish)***Ginkgo® Collection**

Item #	Description	PK	Suggested Retail
47005-6	5 PC Place Setting	4	20.00
47000-1	Dinner Knife	12	6.75
47001-8	Dinner Fork	12	5.25
47002-5	Salad Fork	12	4.75
47003-2	Dinner Spoon	12	5.25
47004-9	Teaspoon	12	4.75
47007-0	Serving Spoon	12	10.00
47012-4	Cold Meat Fork	12	10.00
47013-1	Pierced Serving Spoon	12	10.00
47030-8	3 PC Serving Set	6	25.00
47015-5	20 PC Set	6	60.00
47042-1	42 PC Set (8-5Pc Place Setting and 2-Serving Spoons)	4	120.00

Item #	Description	PK	Suggested Retail
85305-7	5 PC Place Setting	4	20.00
85300-2	Dinner Knife	12	6.75
85301-9	Dinner Fork	12	5.25
85302-6	Salad Fork	12	4.75
85303-3	Dinner Spoon	12	5.25
85304-0	Teaspoon	12	4.75
85309-5	Butter Spreader	12	3.00
85311-8	Cocktail Fork	12	3.00
85340-8	Demitasse Spoon	12	3.00
85308-8	Butter Knife	12	6.25
85307-1	Serving Spoon	12	10.00
85313-2	Pierced Serving Spoon	12	10.00
85325-5	Sugar Shell	12	4.75
85312-5	Cold Meat Fork	12	10.00
85318-7	Sauce Ladle	12	10.00
85315-6	20 PC Set	6	60.00
85342-2	42 PC Set (8-5Pc Place Setting and 2-Serving Spoons)	4	120.00
85331-6	4 PC Hostess Set Serving Spoon, Pr'cd Spoon, Cold Meat Fork, Sauce Ladle	6	35.00

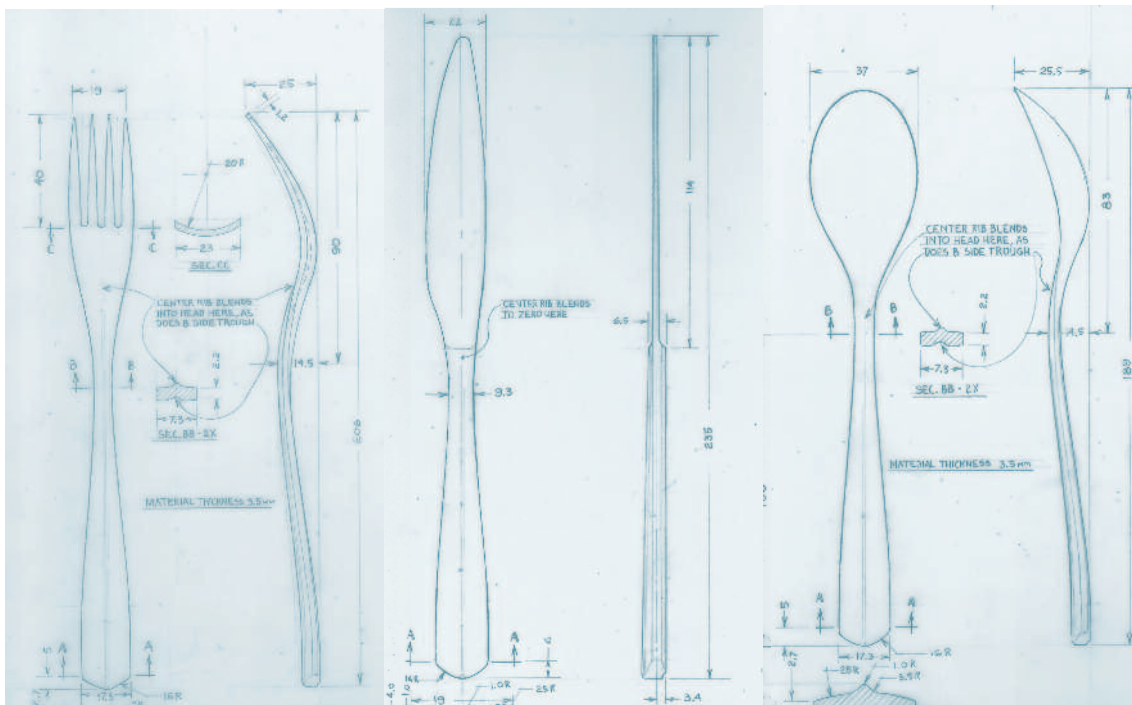

Ginkgo® Select

Burton™

(Mirror Finish 18/10 Stainless)

Ginkgo® Select



Item #	Description	PK	Suggested Retail
13205-9	5 PC Place Setting	4	30.00
13200-4	Dinner Knife	12	9.90
13201-1	Dinner Fork	12	7.85
13202-8	Salad Fork	12	7.15
13203-5	Dinner Spoon	12	7.85
13204-2	Teaspoon	12	7.15
13207-7	Serving Spoon	12	15.00
13212-1	Cold Meat Fork	12	15.00
13213-8	Pierced Serving Spoon	12	15.00
13218-3	Sauce Ladle	12	15.00
13242-8	42 PC Set (8-5Pc Place Setting and 2-Serving Spoons)	4	180.00
13231-2	4 Pc Hostess Set	6	50.00
13215-2	20 PC Set	4	90.00

Charlie™

(Mirror Finish 18/10 Stainless)

Ginkgo® Select



Item #	Description	PK	Suggested Retail
70005-4	5 PC Place Setting	4	25.00
70000-9	Dinner Knife	12	6.00
70001-6	Dinner Fork	12	6.00
70002-3	Salad Fork	12	5.00
70003-0	Dinner Spoon	12	6.00
70004-7	Teaspoon	12	5.00
70009-2	Butter Spreader	12	4.00
70011-5	Cocktail Fork	12	4.00
70040-5	Demitasse Spoon	12	4.00
70007-8	Serving Spoon	6	10.00
70012-2	Cold Meat Fork	6	10.00
70018-4	Sauce Ladle	6	10.00
70042-9	42 PC Set (8-5Pc Place Setting and 2-Serving Spoons)	4	140.00
70030-6	3 Pc Serving Set	4	27.00
70015-3	20 PC Set	4	70.00

Ginkgo® Select *(Bright Finish 18/10 Stainless)*

Fontur™ Platinum

Mirror Finish with Platinum Insert

Item #	Description	PK	Suggested Retail
30105-3	5 PC Place Setting	4	30.00
30100-8	Dinner Knife	12	9.90
30101-5	Dinner Fork	12	7.85
30102-2	Salad Fork	12	7.15
30103-7	Dinner Spoon	12	7.85
30104-6	Teaspoon	12	7.15
30107-7	Serving Spoon	4	15.00
30112-1	Pierced Serving Spoon	4	15.00
30113-8	Cold Meat Fork	4	15.00
30130-8	3 PC Hostess Set Serving Spoon, Prc'd Spoon, Cold Meat Fork	4	40.00
30142-8	42 PC Set (8-5Pc Place Setting and 2-Serving Spoons)	4	180.00
30115-5	20 PC Set	6	90.00



Ginkgo® Collection — *(Mirror Finish Now 18/10!)*

Naples

Item #	Description	PK	Suggested Retail
56005-4	5 PC Place Setting	4	30.00
56000-9	Dinner Knife	12	9.90
56001-6	Dinner Fork	12	7.85
56002-3	Salad Fork	12	7.15
56003-0	Dinner Spoon	12	7.85
56004-7	Teaspoon	12	7.15
56009-2	Butter Spreader	12	3.00
56011-5	Cocktail Fork	12	3.00
56040-5	Demitasse Spoon	12	3.00
56008-5	Butter Knife	12	6.25
56007-8	Serving Spoon	12	10.00
56012-2	Cold Meat Fork	12	10.00
56013-9	Pierced Serving Spoon	12	10.00
56018-4	Sauce Ladle	12	10.00
56015-3	20 PC Set	6	90.00
56042-9	42 PC Set (8-5Pc Place Setting and 2-Serving Spoons)	4	180.00
56031-3	4 PC Hostess Set Serving Spoon, Prc'd Spoon, Cold Meat Fork, Sauce Ladle	6	35.00

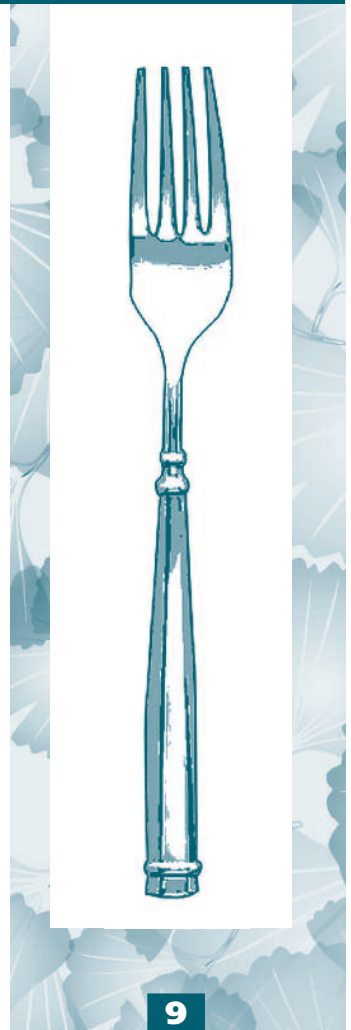



Item #	Description	PK	Suggested Retail
33105-6	5 PC Place Setting	4	20.00
33100-5	Dinner Knife	12	6.75
33101-2	Dinner Fork	12	5.25
33102-9	Salad Fork	12	4.75
33103-6	Dinner Spoon	12	5.25
33104-3	Teaspoon	12	4.75
33109-8	Butter Spreader	12	3.00
33111-1	Cocktail Fork	12	3.00
33140-1	Demitasse Spoon	12	3.00
33108-1	Butter Knife	12	6.25
33107-4	Serving Spoon	12	10.00
33113-5	Pierced Serving Spoon	12	10.00
33112-8	Cold Meat Fork	12	10.00
33118-0	Sauce Ladle	12	10.00
33126-5	Steak Knife	12	7.50
33129-6	Steak Knife-Set/4 Gift Boxed	4	25.00
33115-9	20 PC Set	6	60.00
33142-5	42 PC Set (8-5Pc Place Setting and 2-Serving Spoons)	4	120.00
33131-9	4 PC Hostess Set Serving Spoon, Prc'd Spoon, Cold Meat Fork, Sauce Ladle	6	35.00



Item #	Description	PK	Suggested Retail
16005-6	5 PC Place Setting	4	30.00
16000-1	Dinner Knife	12	9.90
16001-8	Dinner Fork	12	7.85
16002-5	Salad Fork	12	7.15
16003-2	Dinner Spoon	12	7.85
16004-9	Teaspoon	12	7.15
16008-7	Butter Knife	12	4.00
16009-4	Butter Spreader	12	4.00
16040-7	Demitasse Spoon	12	4.00
16007-0	Serving Spoon	12	15.00
16013-1	Pierced Serving Spoon	12	15.00
16018-6	Sauce Ladle	12	15.00
16012-4	Cold Meat Fork	12	15.00
16015-5	20 PC Set	6	90.00
16042-1	42 PC Set (8-5Pc Place Setting and 2-Serving Spoons)	4	180.00
16031-5	4 PC Hostess Set Serving Spoon, Prc'd Spoon, Cold Meat Fork, Sauce Ladle	6	50.00

Item #	Description	PK	Suggested Retail
48005-5	5 PC Place Setting	4	25.00
48000-0	Dinner Knife	12	6.00
48001-7	Dinner Fork	12	6.00
48002-4	Salad Fork	12	5.00
48003-1	Dinner Spoon	12	6.00
48004-8	Teaspoon	12	5.00
48009-3	Butter Spreader	12	4.00
48007-9	Serving Spoon	6	10.00
48013-0	Pierced Serving Spoon	6	10.00
48012-3	Cold Meat Fork	6	10.00
48018-5	Sauce Ladle	12	10.00
48015-4	20 PC Set	6	75.00
48042-0	42 PC Set (8-5Pc Place Setting and 2-Serving Spoons)	4	140.00
48031-7	4 PC Hostess Set - Serving Spoon, Prc'd Spoon, Cold Meat Fork, Sauce Ladle	4	35.00



Item #	Description	PK	Suggested Retail
14005-8	5 PC Place Setting	4	30.00
14105-5	5 PC Place Setting with Hollow Handle Knife	4	35.00
14000-3	Dinner Knife	12	9.90
14100-3	Dinner Knife with Hollow Handle	12	15.00
14001-0	Dinner Fork	12	7.85
14002-7	Salad Fork	12	7.15
14003-4	Dinner Spoon	12	7.85
14004-1	Teaspoon	12	7.15
14008-9	Butter Knife	12	4.00
14007-2	Serving Spoon	12	15.00
14013-3	Pierced Serving Spoon	12	15.00
14012-6	Cold Meat Fork	12	15.00
14042-3	42 PC Set (8-5Pc Place Setting and 2-Serving Spoons)	4	180.00
14015-7	20 PC Set	6	90.00
14031-7	4 PC Hostess Set Serving Spoon, Prc'd Spoon, Cold Meat Fork, Butter Knife	4	50.00



Ginkgo® Steak Knife Collection



67813-1



67823-0

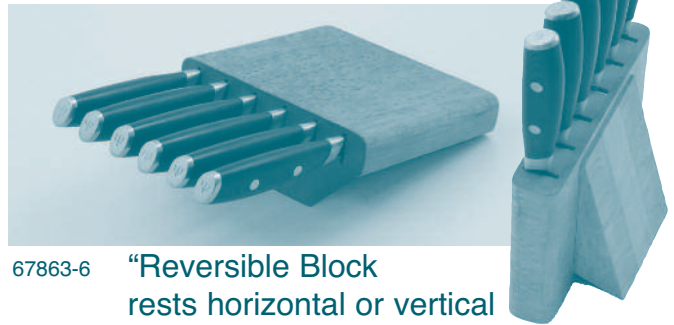

67863-6 "Reversible Block rests horizontal or vertical"

Item #	Description	PK	Suggested Retail
67813-1	Tsuchimon Steak Knife 4.5" Blade	1	125.00
67823-0	Set/2 Tsuchimon Steak Knives	1	240.00
67863-6	Set/6 Tsuchimon Steak Knives w/ Block	1	600.00
14427-8	Trattoria 10" Jumbo Steak Knife	12	6.00
14428-5	Ranch House Steak Knife 10"	12	6.00
36026-5	Lafayette 9" Steak Knife	12	7.50
36029-6	Lafayette Set/4 Steak Knives - Gift Box	4	25.00
33126-5	Norse 9" Steak Knife	12	7.50
33129-6	Norse Steak Knife-Set/4 Gift Boxed	4	25.00



14427-8



14428-5



36026-5



36029-6



33126-5



33129-6

Helmick® Collection

Helmick® Collection (18/10 Stainless- Mirror Finish)

Alsace™

*Heavy weight, classic design
— Inspired by 17th century silversmiths.*

Item #	Description	PK	Suggested Retail
15005-7	5 PC Place Setting	4	40.00
15006-4	5 PC Place Setting - <i>with Hollow Knife</i>	4	45.00
15000-2	Dinner Knife - <i>Mono-Block</i>	12	14.00
15011-8	Dinner Knife - <i>with Hollow Handle</i>	12	19.00
15001-9	Dinner Fork	12	9.00
15002-2	Salad Fork	12	8.00
15003-3	Dinner Spoon	12	9.00
15004-0	Teaspoon	12	8.00
15009-5	Butter Spreader	12	5.00
15008-8	Dessert Knife	12	10.00
15040-8	Demitasse Spoon	12	5.00
15024-5	Tart Server	12	15.00
15026-2	Seafood Fork	12	5.00
15019-6	Mini Sauce Ladle	12	10.00
15022-4	Citrus Fork	12	4.50
15025-1	Cheese Knife	12	10.00
15014-4	Buffet (Tomato) Server	12	11.00
15020-0	Fish Knife	12	10.00
15021-7	Fish Fork	12	10.00
15007-1	Serving Spoon	12	18.00
15013-2	Pierced Serving Spoon	12	18.00
15012-5	Cold Meat Fork	12	18.00
15018-7	Sauce Ladle	12	18.00
15015-6	20 PC Set	6	120.00
15031-6	4 PC Hostess Set <i>Serving Spoon, Prc'd Spoon, Cold Meat Fork, Sauce Ladle</i>	6	60.00
15035-4	5 PC Serving Set - <i>Tart Server, Mini Sauce Ladle, Citrus Fork, Cheese Knife, Buffet/Tomato Server</i>	4	60.00
15017-0	Set of 4 Butter Spreaders	12	20.00
15016-3	Set of 4 Demitasse Spoons	12	20.00
15027-9	Set of 4 Seafood Forks	12	20.00



Celine Platinum™ (18/10 Stainless Mirror Finish)

Helmick® Collection



Item #	Description	PK	Suggested Retail
26105-0	5 PC Place Setting	4	40.00
26100-5	Dinner Knife - Mono Block	12	14.00
26101-2	Dinner Fork	12	9.00
26102-9	Salad Fork	12	8.00
26103-6	Dinner Spoon	12	9.00
26104-3	Teaspoon	12	8.00
26107-4	Serving Spoon	12	18.00
26113-5	Pierced Serving Spoon	12	18.00
26112-8	Cold Meat Fork	12	18.00
26118-0	Sauce Ladle	12	18.00
26115-9	20 PC Set	6	120.00
26131-9	4 PC Hostess Set Serving Spoon, Prc'd Spoon, Cold Meat Fork, Sauce Ladle	4	60.00

Firenzé™

(18/10 Stainless Mirror Finish)

Helmick® Collection

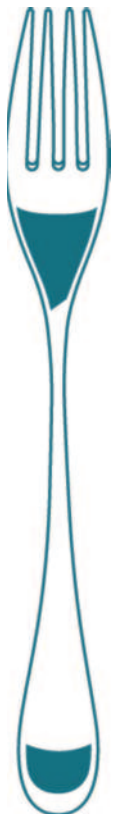

Item #	Description	PK	Suggested Retail
25005-4	5 PC Place Setting	4	40.00
25105-1	5 PC Place Setting - <i>with Hollow Knife</i>	4	45.00
25000-9	Dinner Knife	12	14.00
25100-6	Dinner Knife - <i>with Hollow Knife</i>	12	16.00
25001-6	Dinner Fork	12	9.00
25002-3	Salad Fork	12	8.00
25003-0	Dinner Spoon	12	9.00
25004-7	Teaspoon	12	8.00
25009-2	Butter Spreader	12	5.00
25040-5	Demitasse Spoon	12	5.00
25011-7	Cocktail Fork	12	5.00
25007-8	Serving Spoon	12	18.00
25012-2	Cold Meat Fork	12	18.00
25013-9	Pierced Serving Spoon	12	18.00
25018-4	Sauce Ladle	12	18.00
25015-3	20 PC Set	6	120.00
25031-3	4 PC Hostess Set Serving Spoon, Prc'd Spoon, Cold Meat Fork, Sauce Ladle	6	60.00
25017-7	Set of 4 - Butter Spreaders	12	20.00
25016-0	Set of 4 - Demitasse Spoons	12	20.00
25019-1	Set of 4 - Cocktail Forks	12	20.00

Item #	Description	PK	Suggested Retail
42005-1	5 PC Place Setting	4	40.00
42000-6	Dinner Knife	12	14.00
42001-3	Dinner Fork	12	9.00
42002-0	Salad Fork	12	8.00
42003-7	Dinner Spoon	12	9.00
42004-4	Teaspoon	12	8.00
42009-9	Butter Spreader	12	5.00
42017-4	Cake Server	12	25.00
42007-5	Serving Spoon	12	18.00
42013-6	Pierced Serving Spoon	12	18.00
42012-9	Cold Meat Fork	12	18.00
42018-1	Sauce Ladle	12	18.00
42015-0	20 PC Set	6	120.00
42031-0	4 PC Hostess Set Serving Spoon, Pre'd Spoon, Cold Meat Fork, Sauce Ladle	6	60.00
42021-1	Set of 4 - Butter Spreaders	12	20.00



www.ginkgoint.com



"Our Signature Pattern!"

Patent # D431961

Item #	Description	PK	Suggested Retail
40005-3	5 PC Place Setting	4	40.00
40205-7	5 PC Place Setting <i>with Hollow Knife</i>	4	45.00
40000-8	Dinner Knife	12	14.00
40100-5	Dinner Knife - <i>with Hollow Handle</i>	12	16.00
40001-5	Dinner Fork	12	9.00
40002-2	Salad Fork	12	8.00
40003-9	Dinner Spoon	12	9.00
40004-6	Teaspoon	12	8.00
40009-1	Butter Spreader	12	5.00
40040-4	Demitasse Spoon	12	5.00
40026-8	Seafood Fork	12	5.00
40041-1	Iced Tea Spoon	12	9.00
40007-7	Serving Spoon	12	18.00
40012-1	Cold Meat Fork	12	18.00
40013-8	Pierced Serving Spoon	12	18.00
40018-3	Sauce Ladle	12	18.00
40015-2	20 PC Set	6	120.00
40031-2	4 PC Hostess Set Serving Spoon, Prc'd Spoon, Cold Meat Fork, Sauce Ladle	6	60.00
40021-3	Set of 4 - Butter Spoons	12	20.00
40017-6	Set of 4 - Demitasse Spoons	12	20.00
40019-0	Set of 4 - Seafood Forks	12	20.00

Helmick® Collection

(18/10 Stainless)

LaMer™

All Bright Finish

Item #	Description	PK	Suggested Retail
44005-9	5 PC Place Setting	1	50.00
44000-4	Dinner Knife	12	14.00
44001-4	Dinner Fork	12	12.00
44002-8	Salad Fork	12	8.00
44003-5	Dinner Spoon	12	12.00
44004-2	Teaspoon	12	8.00
44007-3	Serving Spoon	12	20.00
44012-7	Cold Meat Fork	12	20.00
44013-4	Pierced Serving Spoon	12	20.00
44018-9	Sauce Ladle	12	18.00
44015-8	20 PC Set	6	150.00
44031-8	4 PC Hostess Set Serving Spoon, Prc'd Spoon, Cold Meat Fork, Sauce Ladle	6	60.00

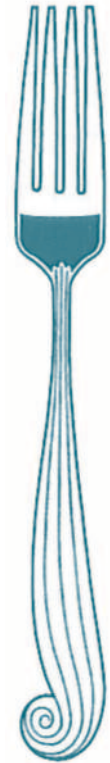

Helmick® Collection (18/10 Stainless Ebony or Ivory P.O.M. handles)

Lyon™

Item #	Description	PK	Suggested Retail
14505-3	Lyon 5pc place set-Ebony	4	40.00
14515-2	Lyon 20pc Set-Ebony	6	150.00
14605-0	Lyon 5pc place set-Ivory	4	40.00
14615-9	Lyon 20pc Set-Ivory	6	150.00

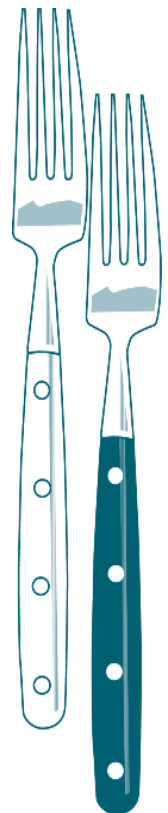



Item #	Description	PK	Suggested Retail
41005-2	5 PC Place Setting	4	40.00
41000-7	Dinner Knife	12	14.00
41001-4	Dinner Fork	12	9.00
41002-1	Salad Fork	12	8.00
41003-8	Dinner Spoon	12	9.00
41004-5	Teaspoon	12	8.00
41009-0	Butter Spreader	12	5.00
41040-3	Demitasse Spoon	12	5.00
41018-2	Dessert Knife	12	8.00
41010-6	Sugar Spoon	12	6.00
41007-6	Serving Spoon	4	18.00
41013-7	Pierced Serving Spoon	4	18.00
41018-2	Sauce Ladle	4	18.00
41012-0	Cold Meat Fork	4	18.00
41031-1	4 PC Hostess Set Serving Spoon, Prc'd Spoon, Cold Meat Fork, Sauce Ladle	4	60.00
41017-5	Set of 4 - Butter Spoons	12	20.00
41016-8	Set of 4 - Demitasse Spoons	12	20.00
41015-1	20 PC Set	6	120.00

Platinum Finish with Mirror Dot



Item #	Description	PK	Suggested Retail
27105-9	5 PC Place Setting	4	40.00
27100-4	Dinner Knife	12	14.00
27101-1	Dinner Fork	12	9.00
27102-8	Salad Fork	12	8.00
27103-5	Dinner Spoon	12	9.00
27104-2	Teaspoon	12	8.00
27107-3	Serving Spoon	12	18.00
27112-7	Cold Meat Fork	12	18.00
27113-4	Pierced Serving Spoon	12	18.00
27118-9	Sauce Ladle	12	18.00
27115-8	20 PC Set	6	120.00
27131-8	4 PC Hostess Set Serving Spoon, Prc'd Spoon, Cold Meat Fork, Sauce Ladle	6	60.00

The classic *hospitality* motif executed in heavy weight 18/10 stainless.
 Patent # D449765

Item #	Description	PK	Suggested Retail
24005-5	5 PC Place Setting	4	40.00
24000-0	Dinner Knife	12	14.00
24001-7	Dinner Fork	12	9.00
24002-4	Salad Fork	12	8.00
24003-1	Dinner Spoon	12	9.00
24004-8	Teaspoon	12	8.00
24008-6	Dessert Knife	12	9.00
24009-3	Butter Spreader	12	4.00
24011-6	Cocktail Fork	12	4.00
24040-6	Demitasse Spoon	12	4.00
24007-9	Serving Spoon	12	18.00
24012-3	Cold Meat Fork	12	18.00
24013-0	Pierced Serving Spoon	12	18.00
24017-8	Cake Server	12	25.00
24018-5	Sauce Ladle	12	18.00
24020-8	Iced Tea Spoon	12	8.00
24021-5	Bouillon Spoon	12	8.00
24025-3	Sugar Shell	12	5.00
24041-3	Pineapple Baby Feeding Spoon	12	3.00
24015-4	20 PC Set	4	120.00
24031-4	4 PC Hostess Set Serving Spoon, Prc'd Spoon, Cold Meat Fork, Sauce Ladle	6	60.00

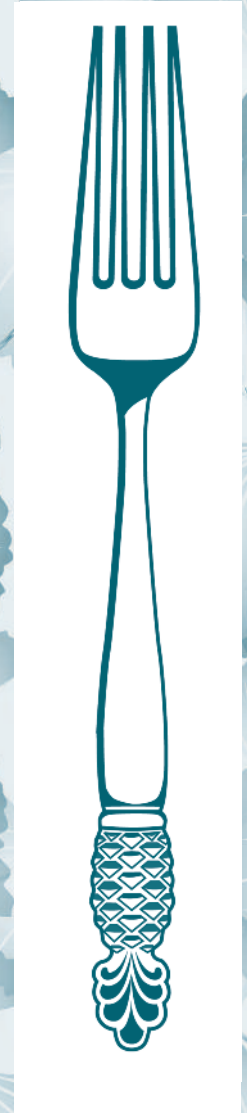

Roberto*(18/10 mirror finish)***Helmick® Collection**

Item #	Description	PK	Suggested Retail
57005-3	5PC Place Setting	4	40.00
57000-8	Dinner Knife	12	14.00
57001-5	Dinner Fork	12	9.00
57002-2	Salad Fork	12	8.00
57003-9	Dinner Spoon	12	9.00
57004-6	Teaspoon	12	8.00
57007-7	Serving Spoon	1	18.00
57012-1	Cold Meat Fork	1	18.00
57013-8	Pierced Serving Spoon	1	18.00
57018-3	Sauce Ladle	1	18.00
57015-2	20 Piece Set	4	120.00
57031-2	4 PC Hostess Set	4	60.00

Shimmer*(18/10 forged, hammered, mirror finish)***Helmick® Collection**

Item #	Description	PK	Suggested Retail
64005-3	5PC Place Setting	4	50.00
64000-8	Dinner Knife	12	14.00
64001-5	Dinner Fork	12	12.00
64002-2	Salad Fork	12	8.00
64003-9	Dinner Spoon	12	12.00
64004-6	Teaspoon	12	8.00
64007-7	Serving Spoon	6	20.00
64012-1	Cold Meat Fork	6	20.00
64013-8	Pierced Serving Spoon	6	20.00
64015-2	20 Piece Set	4	150.00
64030-5	3 PC Hostess Set	6	60.00

Helmick® Premier

Helmick® Premier (18/10 Stainless Mirror Finish)

Classic English™

Item #	Description	PK	Suggested Retail
62005-5	5 PC Place Setting	1	60.00
62000-0	Dinner Knife	12	20.00
62001-7	Dinner Fork	12	15.00
62002-4	Salad Fork	12	12.00
62003-1	Dinner Spoon	12	15.00
62004-8	Teaspoon	12	12.00
62008-6	Butter / Dessert Knife	12	13.00
62007-9	Serving Spoon	12	30.00
62013-0	Pierced Serving Spoon	12	30.00
62018-5	Sauce Ladle	12	30.00
62012-3	Cold Meat Fork	12	30.00
62031-4	4 PC Hostess Set Serving Spoon, Prc'd Spoon, Cold Meat Fork, Sauce Ladle	6	100.00



Helmick® Premier (18/10 Stainless Hammered Finish)

Celtic

Item #	Description	PK	Suggested Retail
63005-4	5 PC Place Setting	1	60.00
63000-9	Dinner Knife	12	20.00
63001-6	Dinner Fork	12	15.00
63002-3	Salad Fork	12	12.00
63003-0	Dinner Spoon	12	15.00
63004-7	Teaspoon	12	12.00
63008-5	Butter / Dessert Knife	12	13.00
63007-8	Serving Spoon	12	30.00
63013-9	Pierced Serving Spoon	12	30.00
63018-4	Sauce Ladle	12	30.00
63012-2	Cold Meat Fork	12	30.00
63031-3	4 PC Hostess Set Serving Spoon, Prc'd Spoon, Cold Meat Fork, Sauce Ladle	6	100.00



To place an order, call: **630.910.5244**

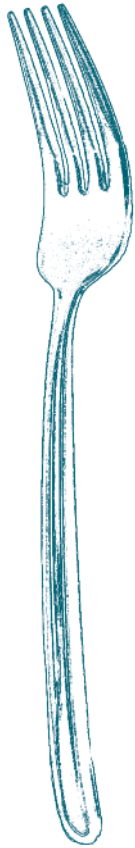

Item #	Description	PK	Suggested Retail
17005-5	5 PC Place Setting	1	60.00
17000-0	Dinner Knife	12	20.00
17001-7	Dinner Fork	12	15.00
17002-4	Salad Fork	12	12.00
17003-1	Dinner Spoon	12	15.00
17004-8	Teaspoon	12	12.00
17007-9	Serving Spoon	12	30.00
17013-0	Pierced Serving Spoon	12	30.00
17018-5	Sauce Ladle	12	30.00
17012-3	Cold Meat Fork	12	30.00
17015-4	20 Piece Set	4	180.00
17031-4	4 PC Hostess Set Serving Spoon, Prc'd Spoon, Cold Meat Fork, Sauce Ladle	6	100.00

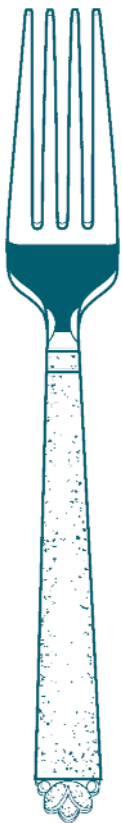

Item #	Description	PK	Suggested Retail
61005-6	5 PC Place Setting	1	40.00
61000-1	Dinner Knife	12	14.00
61001-8	Dinner Fork	12	9.00
61002-5	Salad Fork	12	8.00
61003-2	Dinner Spoon	12	9.00
61004-9	Teaspoon	12	8.00
61008-7	Butter / Dessert Knife	12	9.00
61007-0	Serving Spoon	12	18.00
61013-1	Pierced Serving Spoon	12	18.00
61018-6	Sauce Ladle	12	18.00
61012-4	Cold Meat Fork	12	18.00
61031-5	4 PC Hostess Set Serving Spoon, Prc'd Spoon, Cold Meat Fork, Sauce Ladle	6	60.00

Item #	Description	PK	Suggested Retail
60005-7	5 PC Place Setting	1	60.00
60000-2	Dinner Knife	12	20.00
60001-9	Dinner Fork	12	15.00
60002-6	Salad Fork	12	12.00
60003-3	Dinner Spoon	12	15.00
60004-0	Teaspoon	12	12.00
60008-8	Butter / Dessert Knife	12	13.00
60007-1	Serving Spoon	12	30.00
60013-2	Pierced Serving Spoon	12	30.00
60018-7	Sauce Ladle	12	44.00
60012-5	Cold Meat Fork	12	30.00
60031-6	4 PC Hostess Set Serving Spoon, Prc'd Spoon, Cold Meat Fork, Sauce Ladle	6	100.00

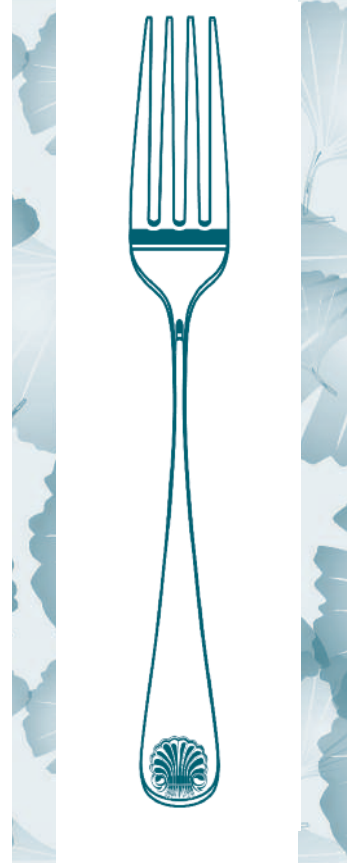

11" Long, 2" wide, 2" high.
10mm candlestick holes.

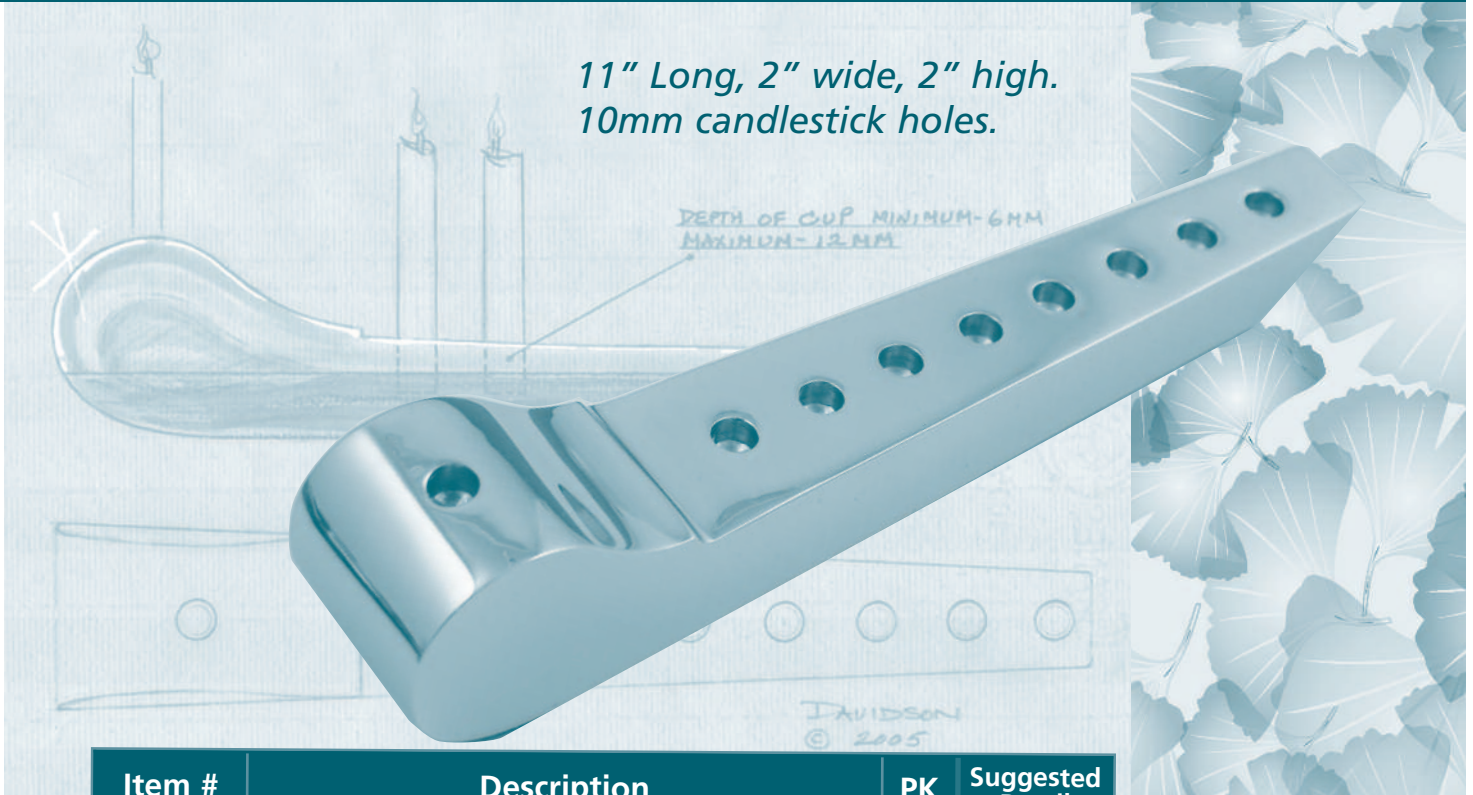

Item #	Description	PK	Suggested Retail
53005-7	Oil Lamp Menorah-Nickel plated brass	1	100.00

Yaxell Knives - SUPER GOU SERIES

161 Layer SG2 Core

Red Linen Micarta Handles

Item #	Description	PK	Suggested Retail
67410-2	10" Chef's Knife	1	600.00
67409-6	10" Slicer	1	500.00
67408-9	9" Bread Knife	1	400.00
67400-3	8" Chef's	1	400.00
67407-2	7" Slicer	1	375.00
67406-5	6" Boner	1	325.00
67401-0	6.5" Santoku	1	400.00
67412-6	5" Santoku	1	350.00
67402-7	5" Utility	1	300.00
67403-4	3.25" Parer	1	250.00
67436-2	6pc Block Set	1	1750.00

Super
豪
SUPER GOU
161 Layers



Yaxell Knives - GOU Series

"The Superb" 101 Layer SG2 Core

Item #	Description	PK	Suggested Retail
67310-5	10" Chef's Knife	1	500.00
67309-9	10" Slicer	1	450.00
67308-2	9" Bread Knife	1	375.00
67300-6	8" Chef's	1	375.00
67301-3	6.5" Santoku	1	375.00
67307-5	7" Slicer	1	325.00
67316-7	6" Slicer	1	300.00
67312-9	5" Santoku	1	300.00
67302-0	5" Utility	1	250.00
67303-7	3.25" Parer	1	200.00
67320-4	GOU 2 PC Gift Set: 6.5" Santoku, ProSharp	1	\$425.00
67333-4	3Pc Knife Set-8" Chef, 5" Utility, Gou ProSharp	1	625.00
67336-5	GOU 6 PC Block Set: 8" Chef, 9" Bread, 7" Slicer, 5" Santoku, 3.25" Parer	1	1,500.00

豪
GOU
101 Layers



MADE IN JAPAN
Since 1932



Yaxell Knives - RAN SERIES

9 layers-VG10 Core



嵐

RAN
69 Layers



Item #	Description	PK	Suggested Retail
67010-4	10" Chef's Knife	1	250.00
67019-7	Chinese Chef's Knife (cleaver style)	1	270.00
67009-8	10" Slicer	1	250.00
67008-1	9" Bread Knife	1	230.00
67000-5	8" Chef's Knife	1	200.00
67007-4	7" Slicer	1	175.00
67004-3	7" Nakiri/Vegetable Knife	1	200.00
67026-5	Panini Knife	1	180.00
67001-2	6.5" Santoku Knife	1	200.00
67016-6	6" Slicer	1	165.00
67012-8	5" Santoku	1	180.00
67002-9	5" Utility Knife	1	150.00
67003-6	3.25" Paring Knife	1	135.00
67020-3	RAN 2 Piece Gift Set-8" Chef, RAN Sharp	1	250.00
67033-3	3 Pc. Gift Set-8" Chef, 5" Utility, Sharpener	1	350.00
67036-4	6Pc Knife Block Set-Bread Knife, 8" Chef's Knife, 7" Slicer, 5" Santoku, 3.25" Paring Knife	1	900.00

Yaxell Knives - TSUCHIMON SERIES

3 layers



鋤紋

TSUCHIMON
3 Layers



Item #	Description	PK	Suggested
67810-0	10" Chef's Knife	1	187.50
67809-4	10" Slicer	1	187.50
67808-7	9" Bread Knife	1	160.00
67800-1	8" Chef's Knife	1	150.00
67807-0	7" Slicer	1	150.00
67801-8	6.5" Santoku	1	150.00
67812-4	5" Santoku	1	130.00
67802-5	5" Utility	1	120.00
67813-1	4.5" Steak Knife	1	120.00
67803-2	3.5" Paring	1	100.00
67823-0	TSUCHIMON 2pc. Steak Knife Set 4.5"	1	240.00
67833-9	Tsuchimon 3pc Gift Set:8" Chef, 5" Utility, RAN Sharp	1	300.00
67863-6	TSUCHIMON 6pc. Steak Knife Set with Maple Block	1	600.00
67836-0	6PC BLOCK- 8" Chef Knife, 9" Bread Kn, 7"Slicer, 5" Santoku, 3.25" Parer	1	720.00

Yaxell Knives - Gift Sets

Item #	Description	PK	Suggested Retail
67436-2	SUPER GOU 6 Piece Block Set	1	1,750.00
67336-5	GOU 6 Piece Block Set	1	1,500.00
67333-4	GOU 3 Piece Gift Set-8" Chef, 5" Utility, ProSharp	1	625.00
67320-4	GOU 2 Piece Gift Set-6.5" Santoku, ProSharp	1	425.00
67036-4	RAN 6 Pc Block Set-Block, 9" Bread Knife, 8" Chef Kn, 7" Slicer, 5" Santoku, 3.25" Parer	1	900.00
67033-3	RAN 3 Pc Gift Set-8" Chef, 5" Utility, RAN Sharp	1	350.00
67020-3	RAN 2 Piece Gift Set-8" Chef, RAN Sharp	1	250.00
67836-0	TSUCHIMON-6pc Block Set	1	720.00
67823-0	TSUCHIMON 2pc. Steak Knife Set 4.5"	1	240.00
67833-9	TSUCHIMON 3 PC Gift Set: 8" Chef, 5" Utility, RAN Sharp	1	300.00
67836-0	TSUCHIMON 6pc. Steak Knife Set with Maple Block	1	600.00

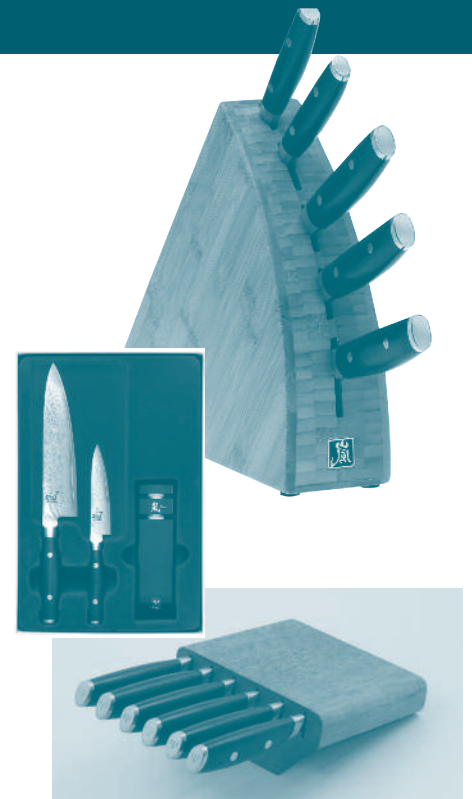

New! Magnet Bars (Made in the USA)

Item #	Description	PK	Suggested Retail
67910-7	5 Position Magnet 12" Bar-Walnut	1	30.00
67911-4	5 Position Magnet 12" Bar-Maple	1	30.00
67912-1	5 Position Magnet 12" Bar-Cherry	1	30.00



Item #	Description	PK	Suggested Retail
67920-6	7 Position Magnet 15" Bar-Walnut	1	40.00
67921-3	7 Position Magnet 15" Bar-Maple	1	40.00
67922-0	7 Position Magnet 15" Bar-Cherry	1	40.00

Yaxell Knives - Sharpening

Item #	Description	PK	Suggested Retail
67322-8	GOU-Sharp Pro knife sharpener-for SG2 & VG10 Steel	1	75.00
67060-9	Japanese Waterstone Double sided-240/1000 grit	1	87.50
67722-1	GOU Sharp Replacement Wheels-Set of 2 (for both RAN & GOU knives)	1	30.00

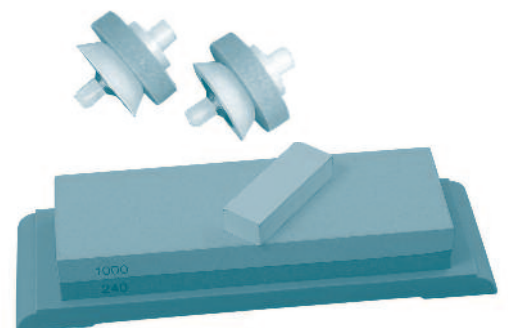



KITCHEN TOOL GINKGO® COLLECTION



Kitchen Tool Collection — Hammered Finish

Item #	Description	Retail
36070-8	Serving Spoon 12.5" 4.0mm	\$15.00
36074-6	Pierced Serving Spoon 12.5" 4.0mm	\$15.00
36071-5	Serving/Meat Fork 12.5" 4.0mm	\$15.00
36072-2	Turner/Spatula 13" 4.0mm	\$15.00
36073-9	Soup/Punch ladle 11" 4.0mm	\$15.00
36078-4	2Pc. Salad Set 10.5" 4.0mm	\$25.00
36300-6	Paring Knife 3.5" on Hang Tag	\$10.00
36312-9	Paring Knife-Set/12 in Display Box	\$120.00
36301-3	Utility/Tomato Knife 4.5" Hang Tag	\$11.00
36302-0	Santoku/Cheese Knife 4.75" Hang Tag	\$12.00
36079-1	Bottle Opener Forged 18/10-5mm	12.00

- Generously sized, super strong, 4.0mm thick pieces
- Comfortable, attractive, rounded handles
- Serving Fork designed to pick up the heaviest roasts/turkeys
- Soup/Punch ladle beautifully curved, with 4 ounce bowl
- Spatula head is fully tempered to flex, and then brazed to handle.
- Attractive, informative, eco-friendly hang tag, w/UPC



PANDA BABIES



Package Deal
 • *Free Display*

Qty	Item#	Description	Sugg. Rtl	Exten.
1	22885-5	Panda Babies Display Rack-Empty	100.00	0.00
6	36202-3	3 Piece Baby & Toddler Set	12.00	72.00
6	36206-1	6 Piece Progress Set	25.00	150.00
6	36203-0	3 Piece Child Set	15.00	90.00
6	21914-3	3 Piece Child Set-Baby Blue	10.00	60.00
6	21915-0	3 Piece Child Set-Pink	10.00	60.00
6	21916-7	3 Piece Child Set-Green	10.00	60.00
36 Sets	22891-6	Panda Babies Display Full as shown*		492.00

3 Tier Display

24" wide x 24" tall x 12" deep

3-Tier display only #22893

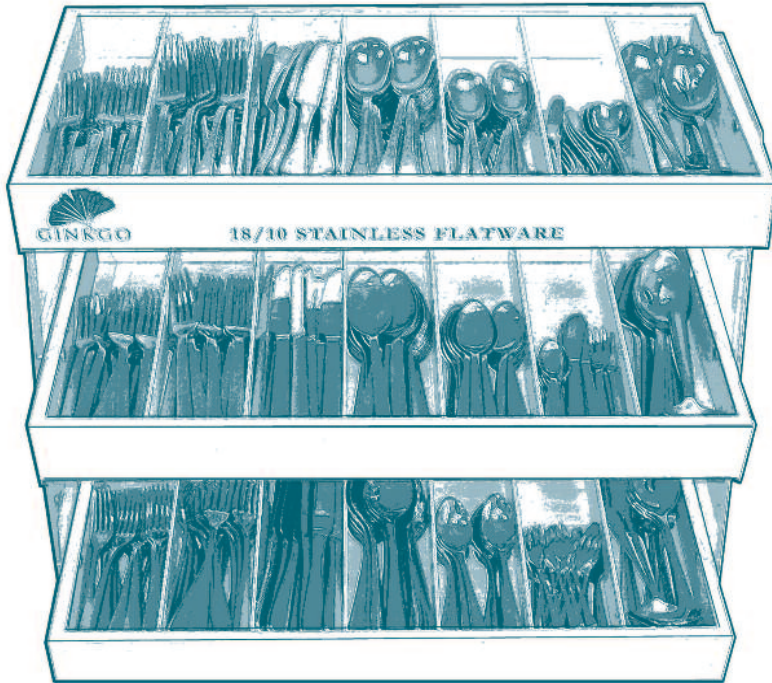

Opening Order for each tier (shelf)
Choose from eligible patterns in the
Ginkgo® Stainless Collection

Qty.	Description	Cost*	Extended
24	Dinner Knives	\$1.50	\$36.00
24	Dinner Forks	\$1.50	\$36.00
24	Salad Forks	\$1.50	\$36.00
24	Dinner Spoons	\$1.50	\$36.00
24	Teaspoons	\$1.50	\$36.00
12	Demitasse Spoons	\$1.50	\$18.00
12	Cocktail Forks	\$1.50	\$18.00
12	Butter Spreaders	\$1.50	\$18.00
3	Serving Spoons	\$3.50	\$10.50
3	Pierced Serving Spoons	\$3.50	\$10.50
3	Cold Meat Forks	\$3.50	\$10.50
3	Sauce Ladles	\$3.50	\$10.50
Totals			
168	3 Tier Unit Cost full of Flatware as shown with Display (3 Patterns of the above assorted. (504 pieces)		\$552.00
	SPECIAL:		
	*Open stock price only available to Display Owners		\$828.00

9 Pocket "Party Pieces" Display

Order 18 dozen "little pieces"
(Spreaders, Cocktails, Demitasse, Iced Teas,
etc.)

Receive a **FREE 9 Pocket Display**
with your shipment!

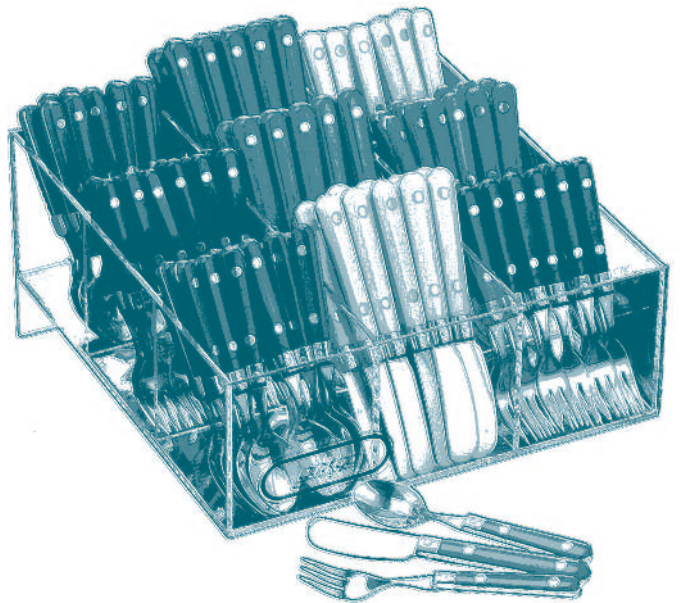



Designing

QUALITY[®]

GINKGO INTERNATIONAL LTD.
8102 Lemont Road, Suite 1100
Woodridge, Illinois 60517
Tel 630.910.5244
Fax 630.910.5279
email: kelly@ginkgoint.com
www.ginkgoint.com